

QUICK INSTALLATION GUIDE



GAMDIAS 
CHIONE | E1A
120R **A**
CPU Liquid Cooler

Package Contents

A

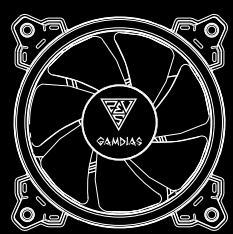

x1

B

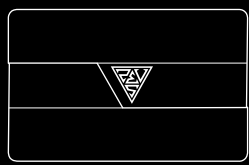

x1

C

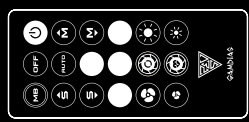

x1

D

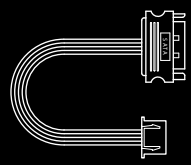

x1

E



x1

F



x1

G

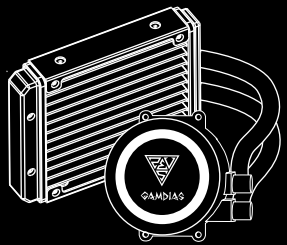

x1

H

x1

I

x4

J

x4

K

x4

L

x4

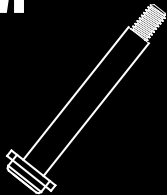
M

x4

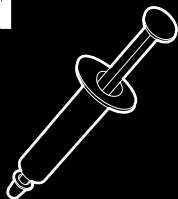
N

x1

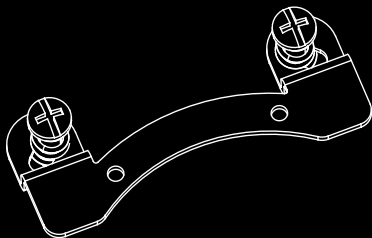
O

x2

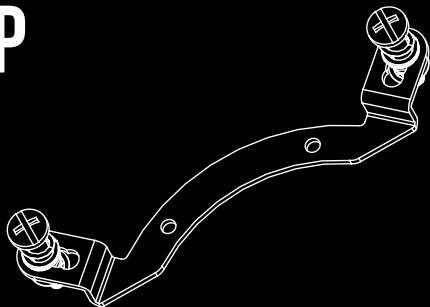
P

x2

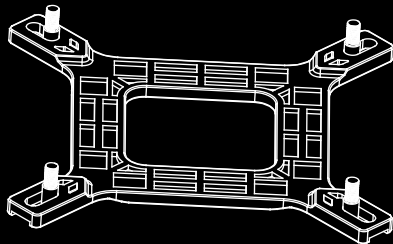
Q

x1

Pump Dimensions

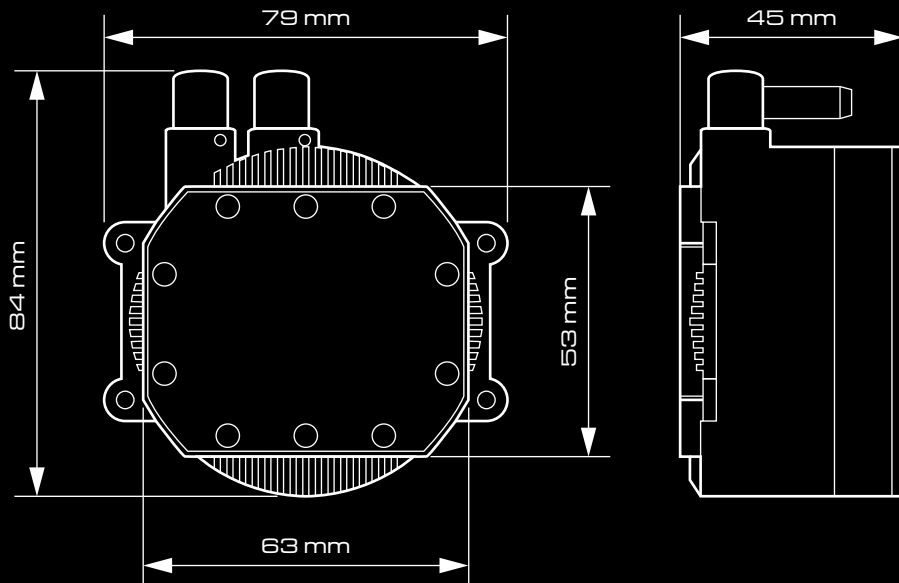

INTEL (LGA1366/115X/775) - 1

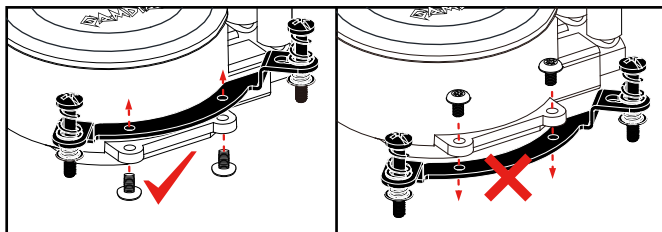
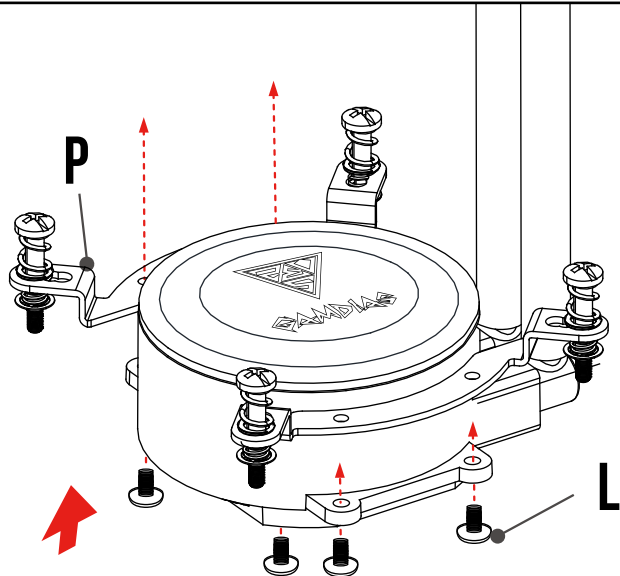

INTEL (LGA 1366 / 115X / 775) - 2

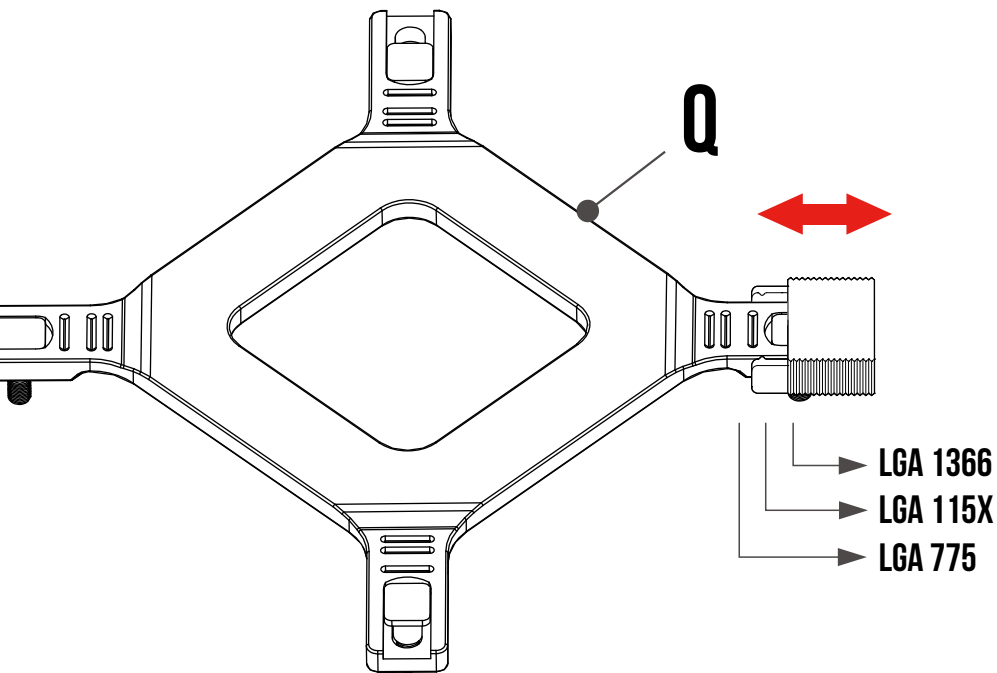

INTEL (LGA1366/115X/775) -3

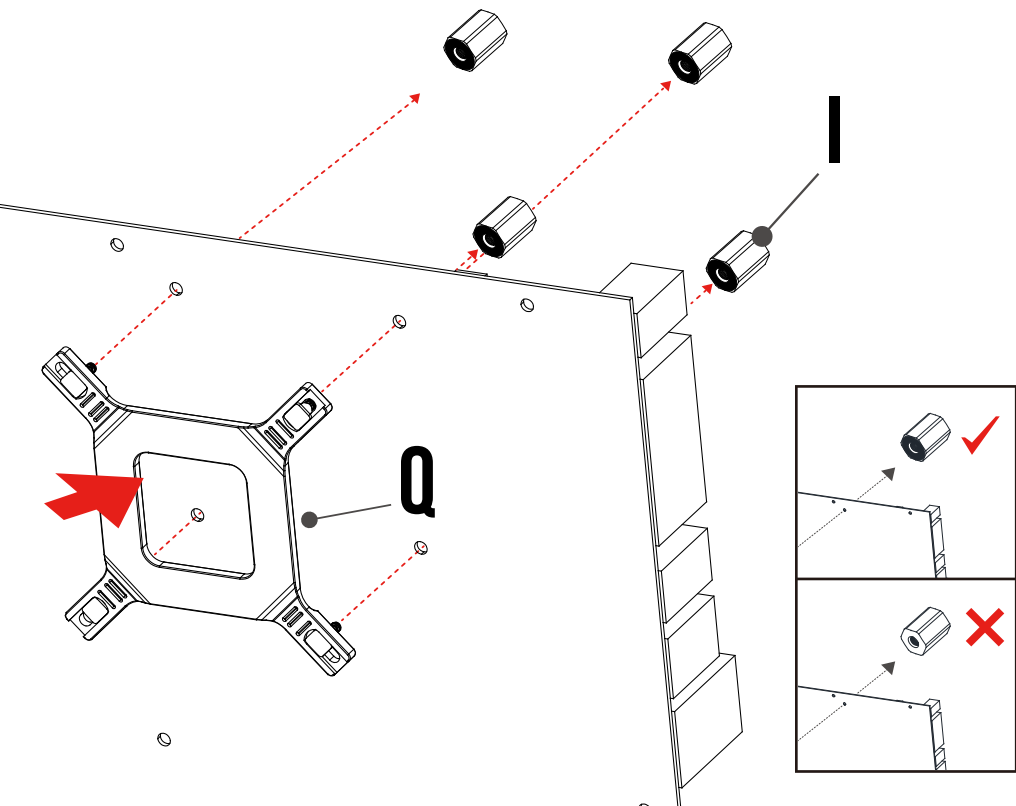

INTEL (LGA 1366/115X/775) -4

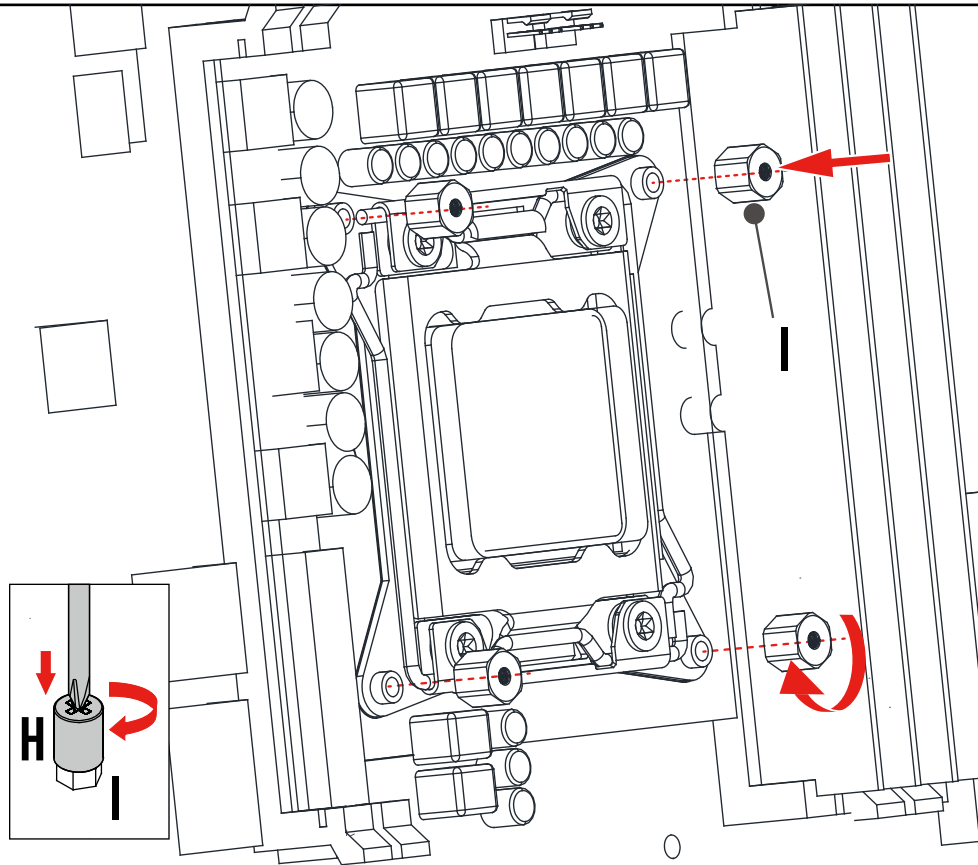

INTEL (LGA1366/115X/775) -5

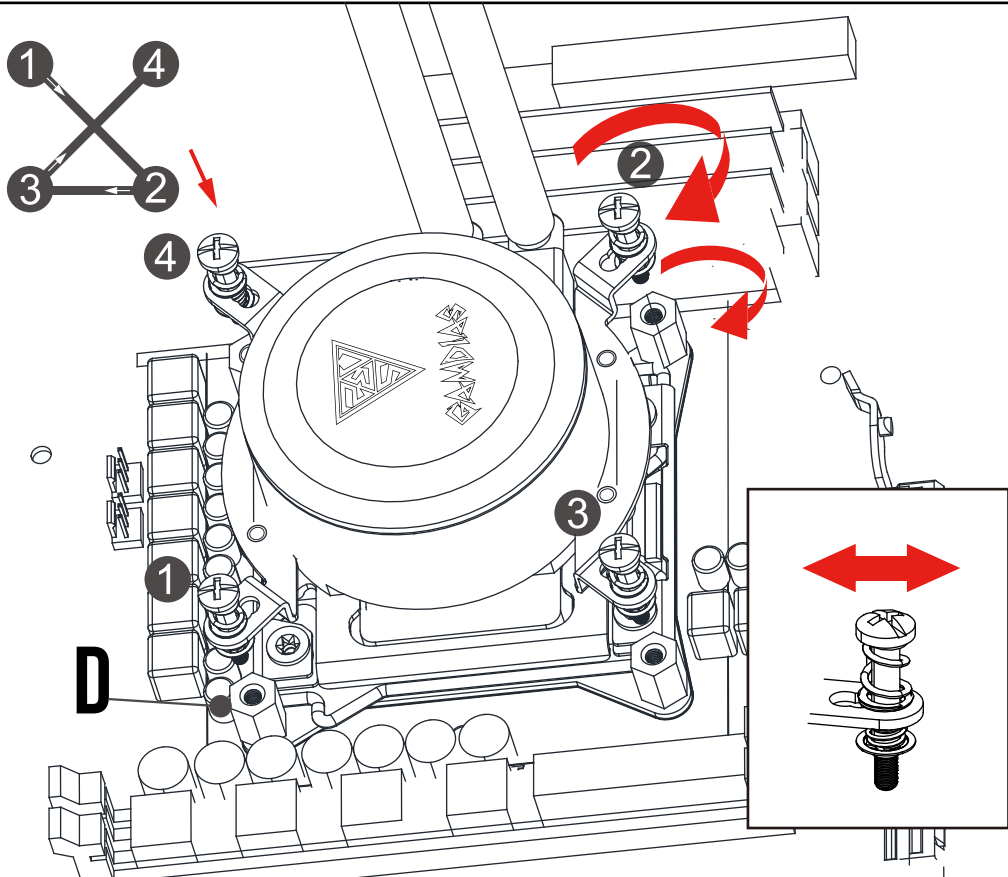

INTEL (LGA2066/2011/2011-3) - 1

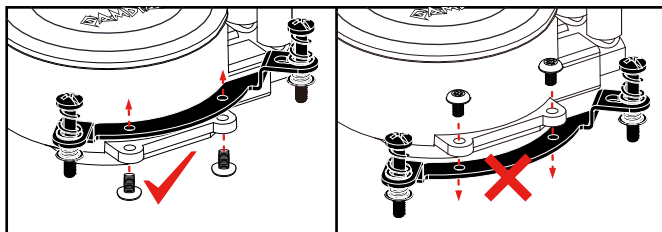
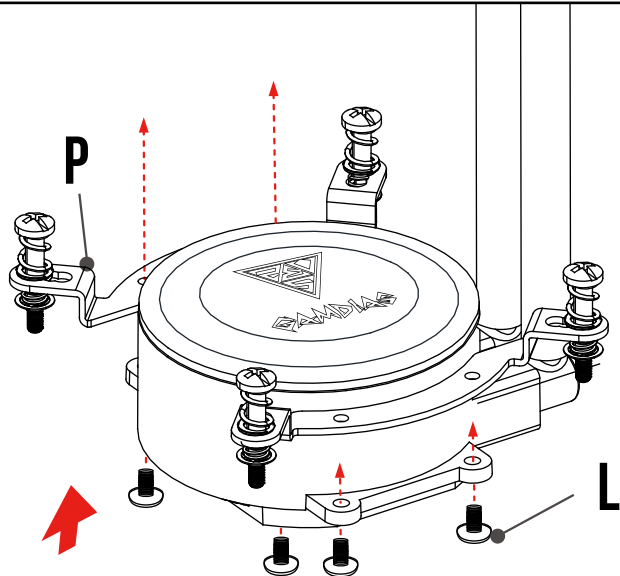

INTEL (LGA2066/2011/2011-3) -2

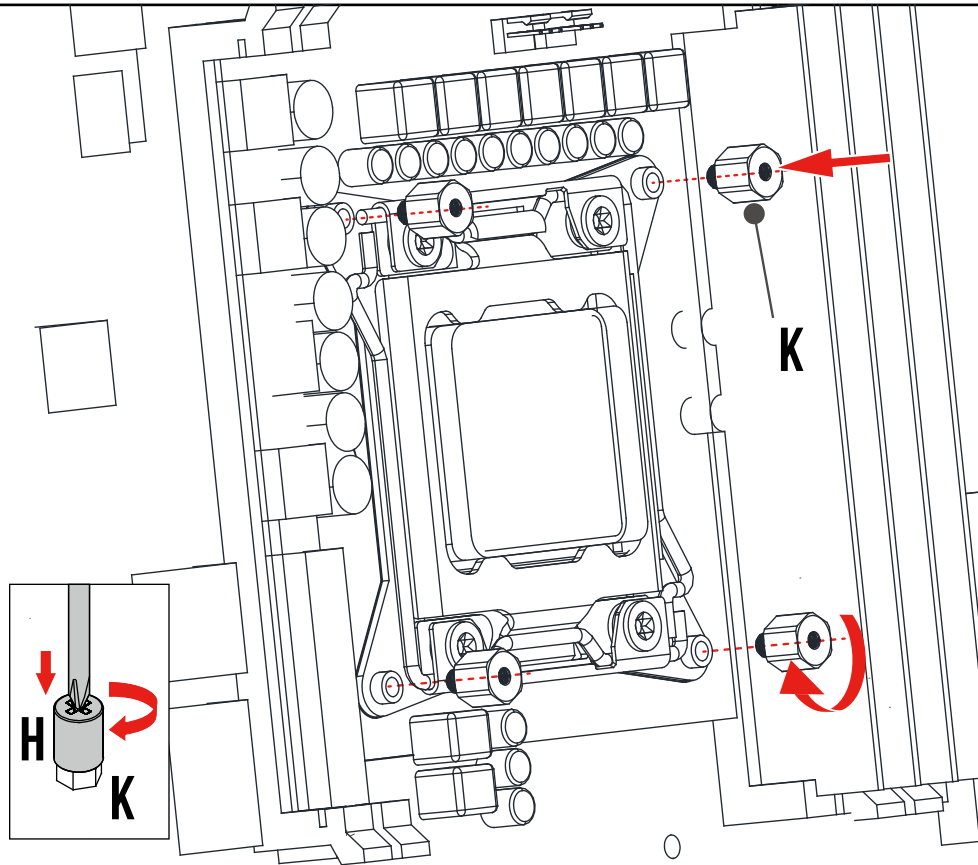

INTEL (LGA2066/2011/2011-3) -3

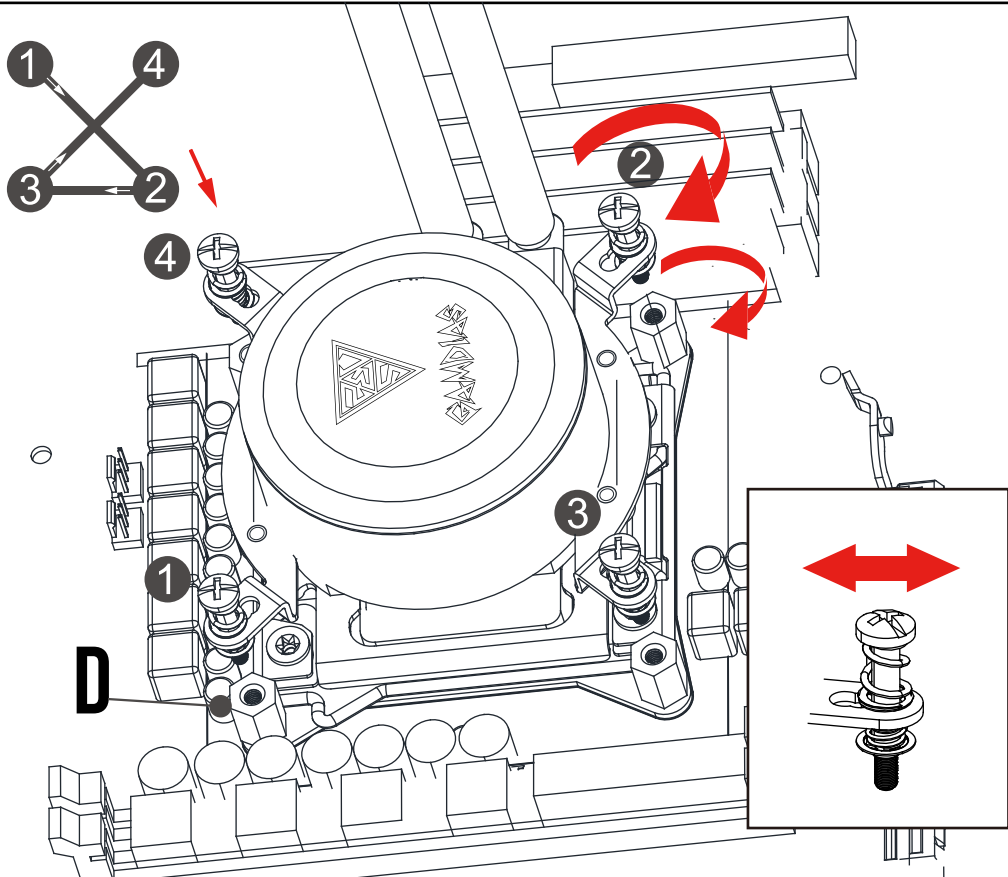

AMD-1

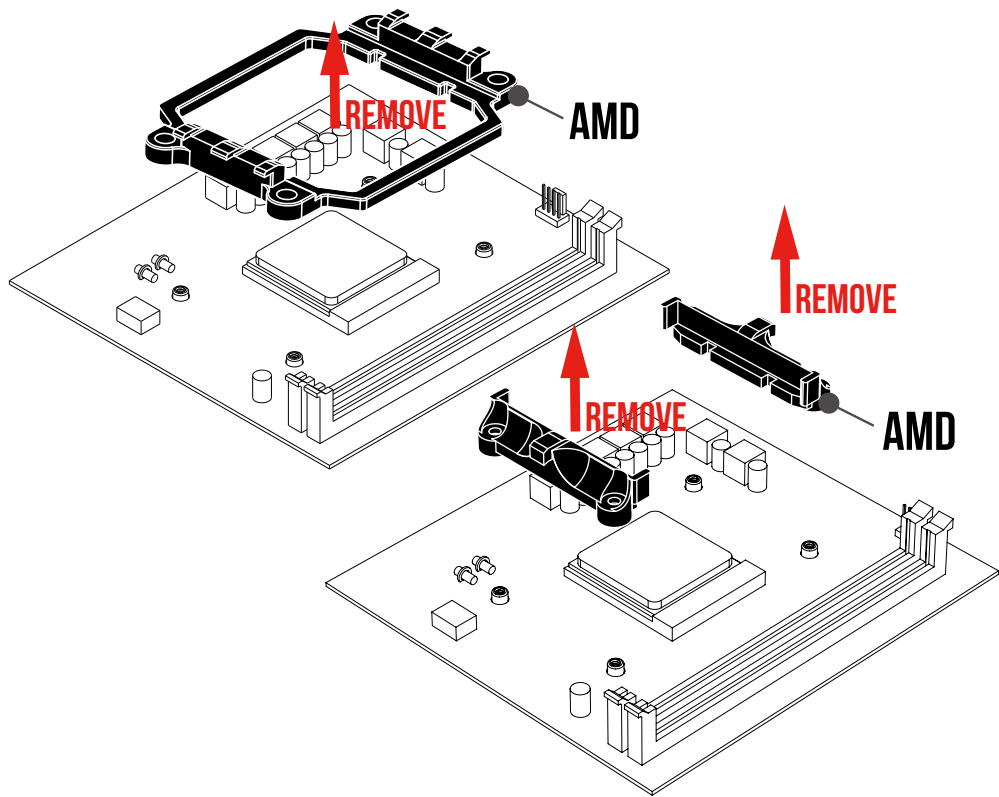

AMD-3

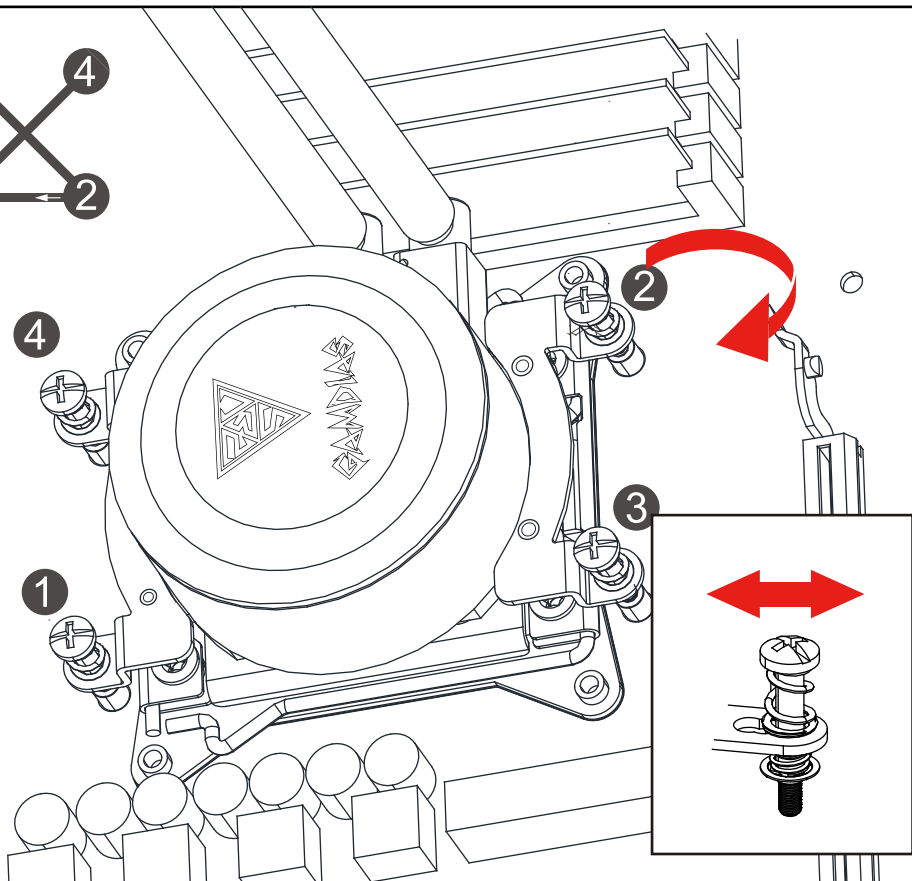
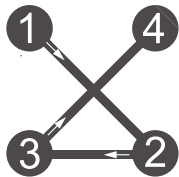

INTEL / AMD-1

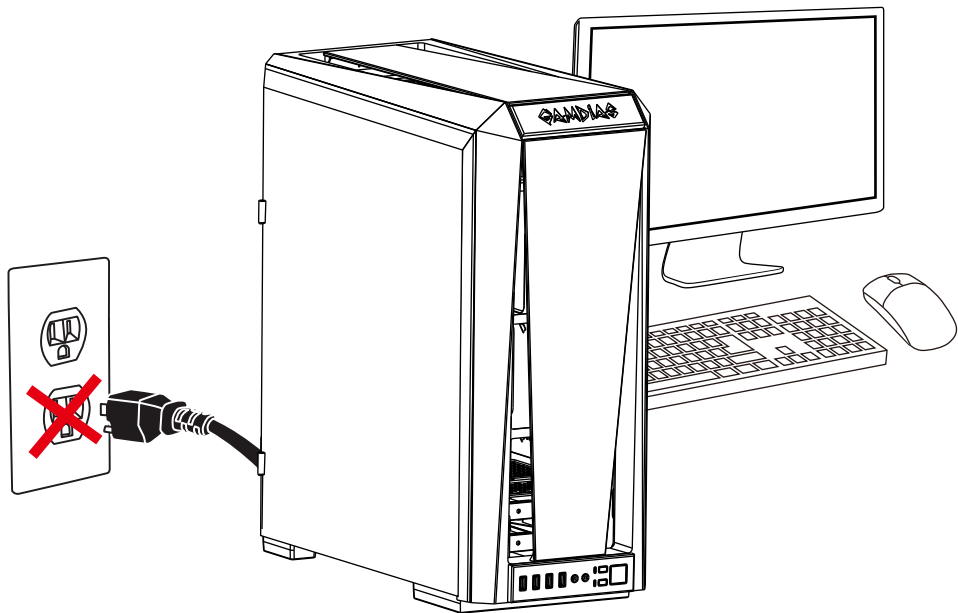

INTEL / AMD-2

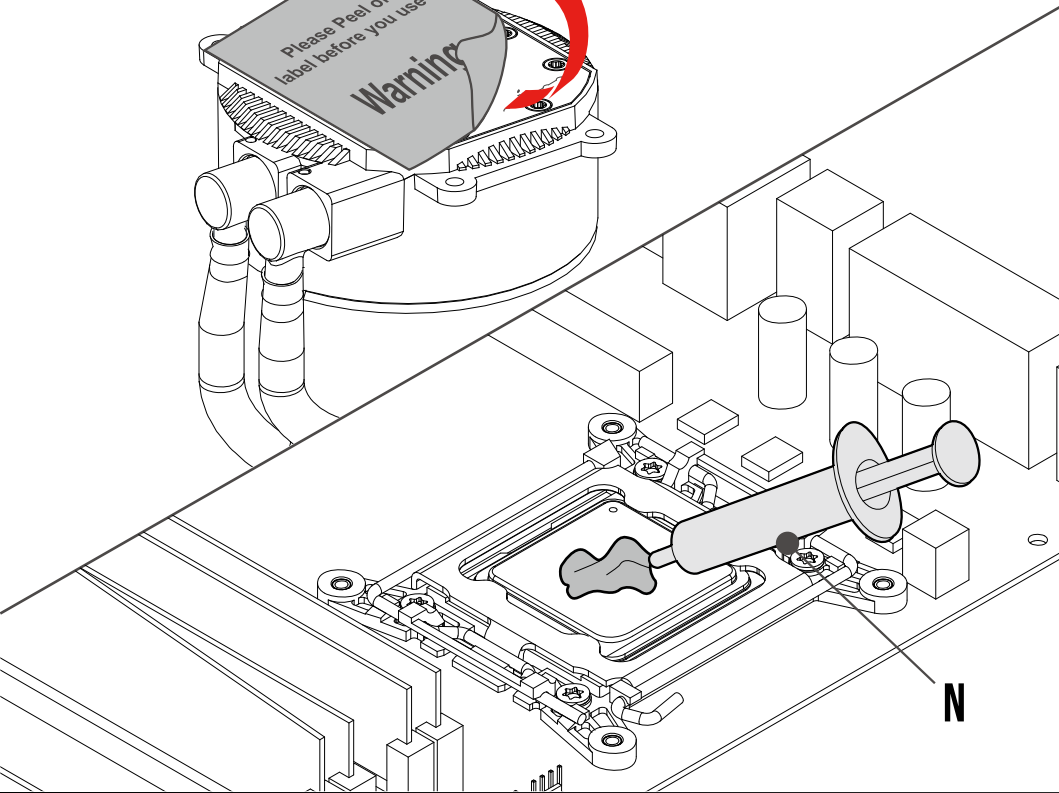
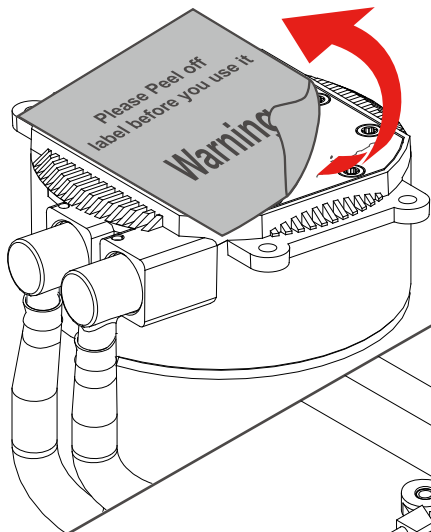

INTEL / AMD-3

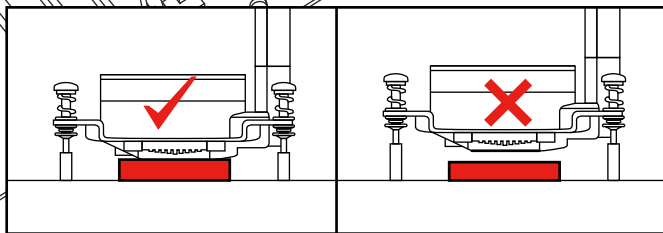
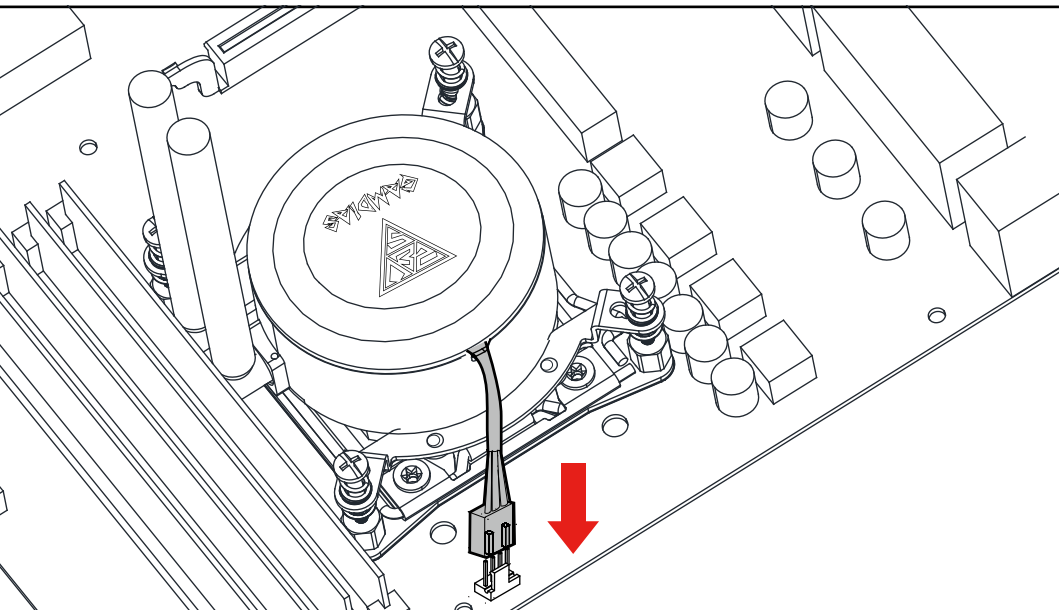

INTEL / AMD-4

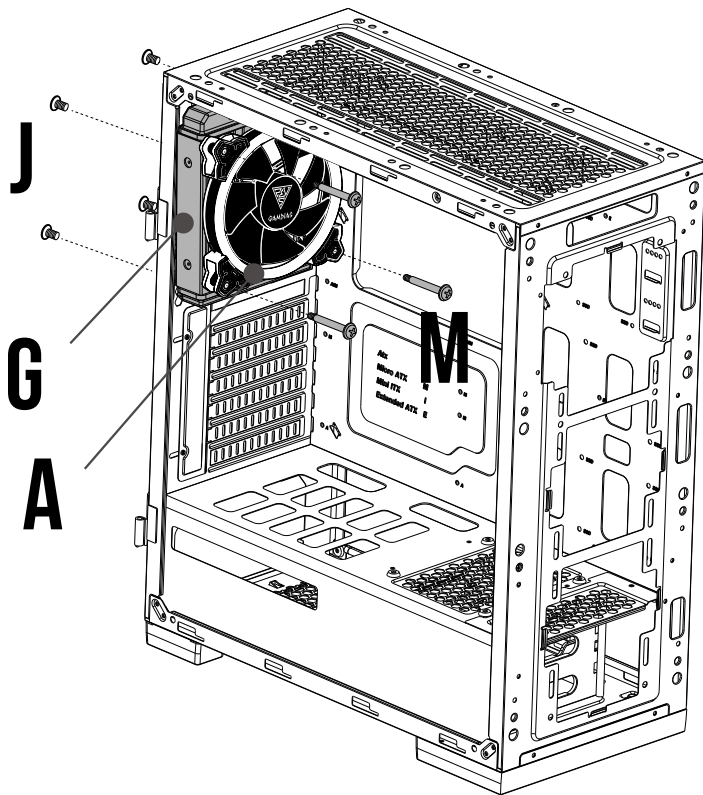

INTEL / AMD-5

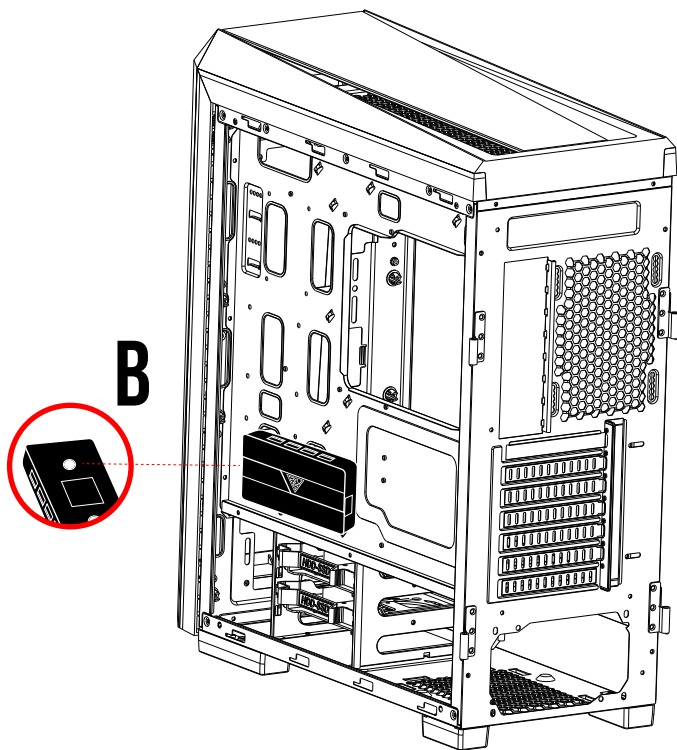

INTEL / AMD-6

Fans must start at "1" and continue in series.

FAN1 → FAN2 → FAN3 → FAN4 → FAN5 → FAN6

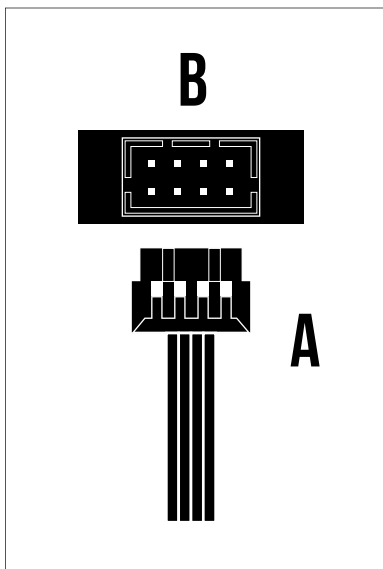
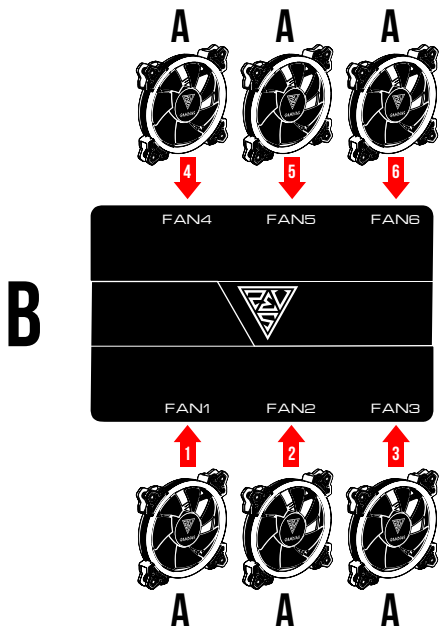

INTEL / AMD-6

English

- ◆ Fans must start at "1" and continue in series.
FAN1 → FAN2 → FAN3 → FAN4 → FAN5 → FAN6
- ◆ Any fan not connected in series will break communication and the RGB lighting function will not work.

Español

- ◆ Los ventiladores deben comenzar en "1" y continuar en serie.
FAN1 → FAN2 → FAN3 → FAN4 → FAN5 → FAN6
- ◆ Cualquier ventilador no conectado en serie romperá la comunicación y no se activará la función de iluminación RGB

Deutsch

- ◆ Lüfter müssen bei „1“ beginnen und in Reihe fortgesetzt werden.
FAN1 → FAN2 → FAN3 → FAN4 → FAN5 → FAN6
- ◆ Jeder nicht in Reihe geschaltete Lüfter unterbricht die Kommunikation und die RGB-Beleuchtung funktioniert nicht

Polski

- ◆ Wentylatory muszą uruchamiać się przy „1” i kontynuować działanie szeregowo.
FAN1 → FAN2 → FAN3 → FAN4 → FAN5 → FAN6
- ◆ Wentylator, który nie jest podłączony szeregowo przerwie komunikację i funkcja oświetlenia RGB nie będzie działać

Français

- ◆ Les ventilateurs doivent commencer à "1" et continuer en série.
FAN1 → FAN2 → FAN3 → FAN4 → FAN5 → FAN6
- ◆ Les ventilateurs non connectés en série rompent la communication et empêchant le fonctionnement de l'éclairage RVB

INTEL / AMD-6

Svensk

- ♦ Fläktar måste starta på "1" och fortsätta i serie.
FAN1 → FAN2 → FAN3 → FAN4 → FAN5 → FAN6
- ♦ Fläktar som inte ansluts i serie kommer att bryta kommunikationen och RGB-belysningsfunktionen kommer inte att fungera

Italiano

- ♦ Le ventole devono partire da "1" e continuare in serie.
FAN1 → FAN2 → FAN3 → FAN4 → FAN5 → FAN6
- ♦ Qualsiasi ventola non collegata in serie interrompe la comunicazione e la funzione di illuminazione RGB non funziona

Português

- ♦ As ventoinhas devem começar em "1" e continuar em série.
FAN1 → FAN2 → FAN3 → FAN4 → FAN5 → FAN6
- ♦ Qualquer ventoinha não conectada em série interromperá a comunicação e a função de iluminação RGB não funcionará

Русский

- ♦ Вентиляторы запускаются с «1» и далее по порядку.
FAN1 → FAN2 → FAN3 → FAN4 → FAN5 → FAN6
- ♦ Если какой-либо из вентиляторов не подключен последовательно, связь прерывается, и функция подсветки RGB не работает

العَرَبِيَّة

- ♦ يجب أن تبدأ المراوح من "1" وتستمر على التوالي. FAN1 ← FAN2 ← FAN3 ← FAN4 ← FAN5 ← FAN6
- ♦ إذا لم يتم توصيل أي مروحة على التوالي، فسيتم قطع الاتصال ولن تعمل وظيفة إضاءة RGB

INTEL / AMD-7

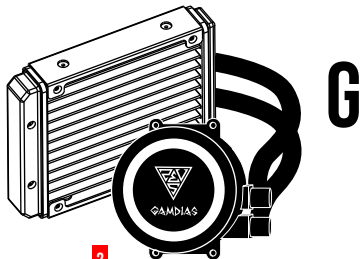

2

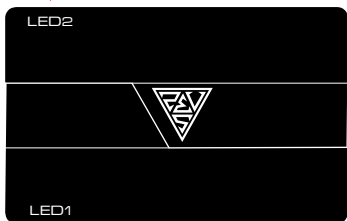

1

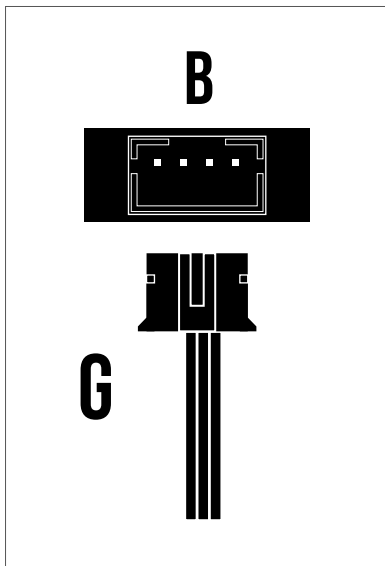
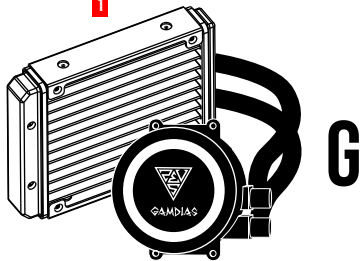

INTEL / AMD-8

ASUS – AURA Addressable Header

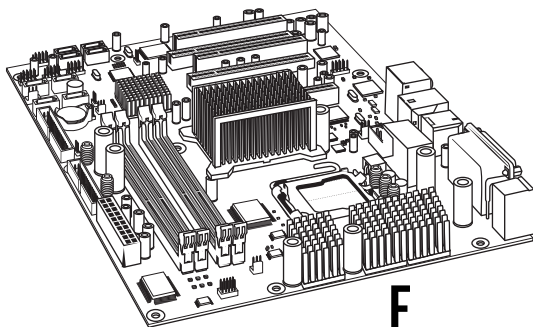

B

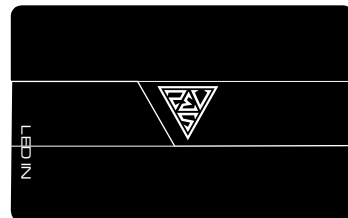

F

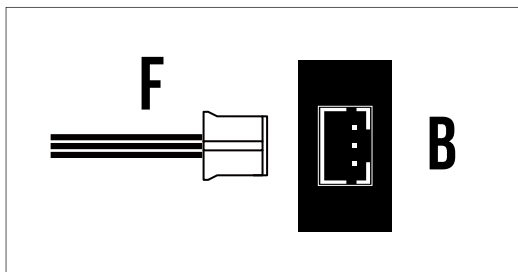
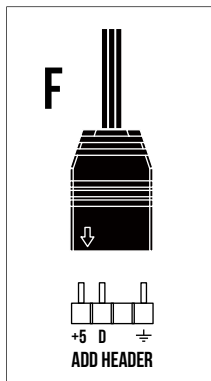

INTEL / AMD-9

MSI - JRAINBOW Header

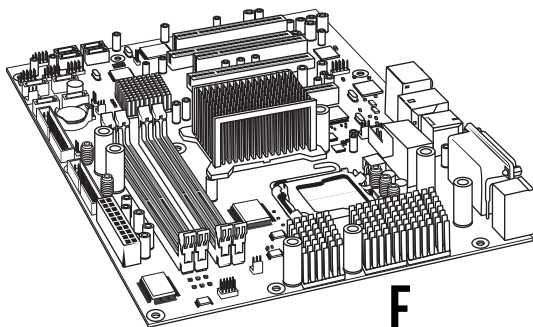

B

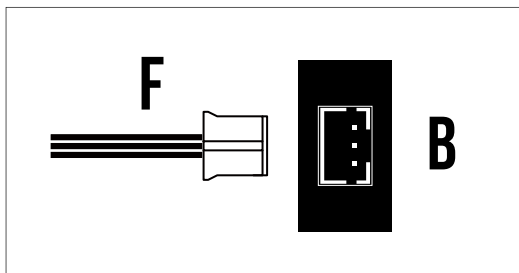
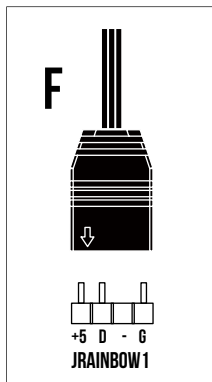
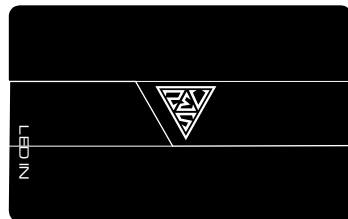

INTEL / AMD-10

ASRock - Addressable LED Header

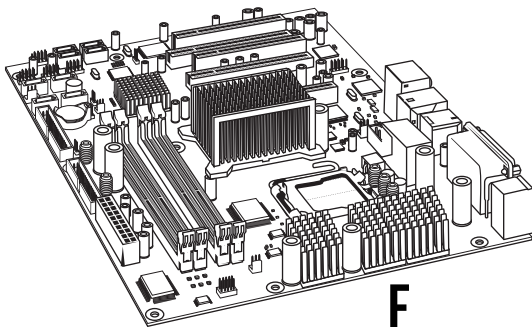

B

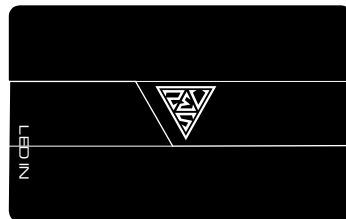

F

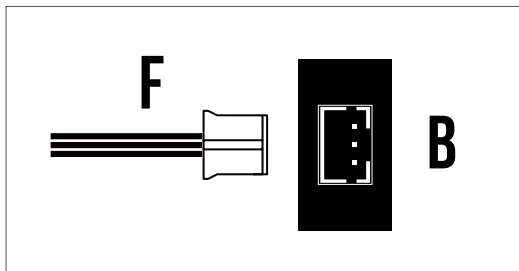
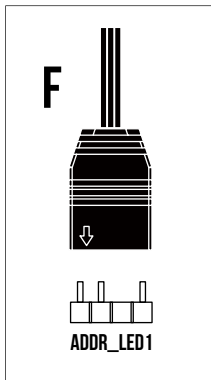

INTEL / AMD-11

GIGABYTE - Digital Pin Header

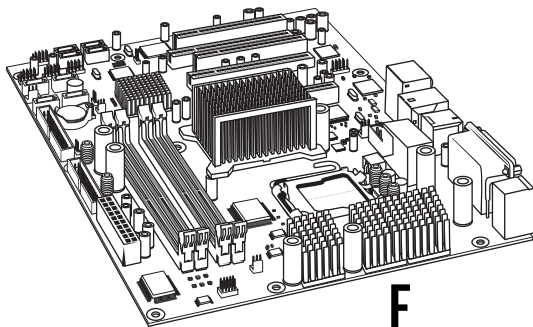

B

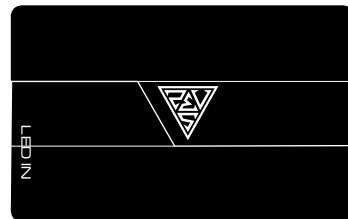

F

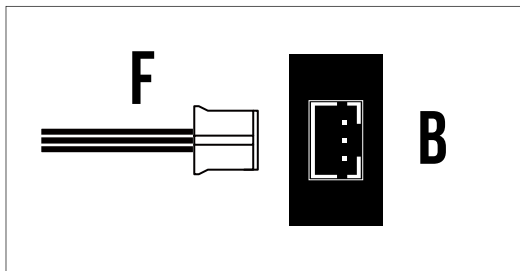
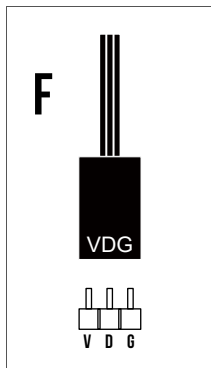
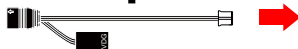

INTEL / AMD-12

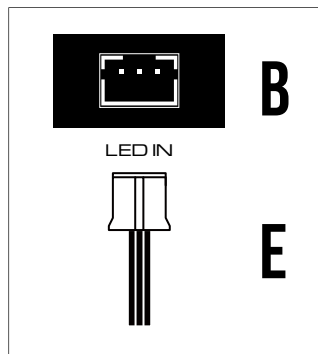
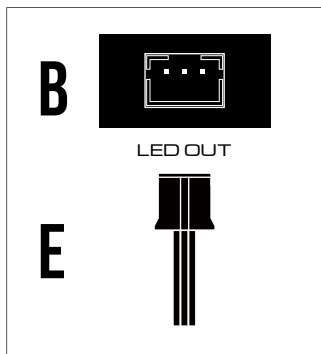
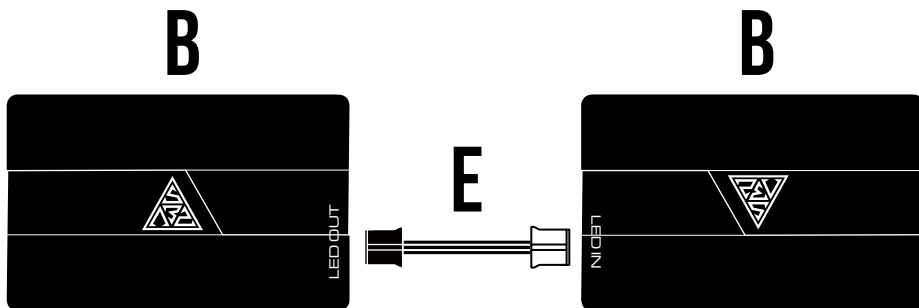

INTEL / AMD-13

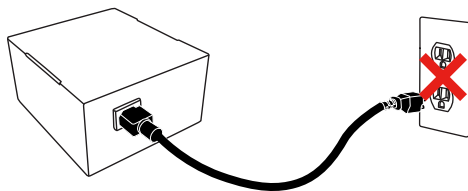
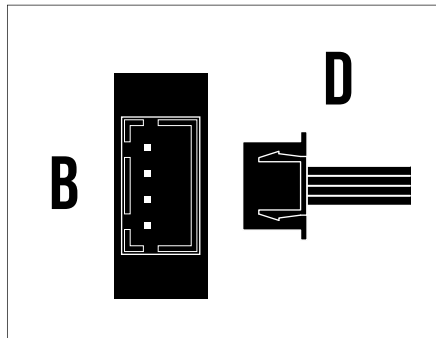
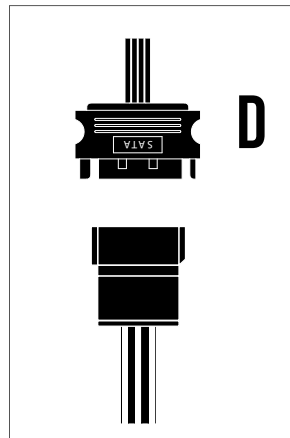
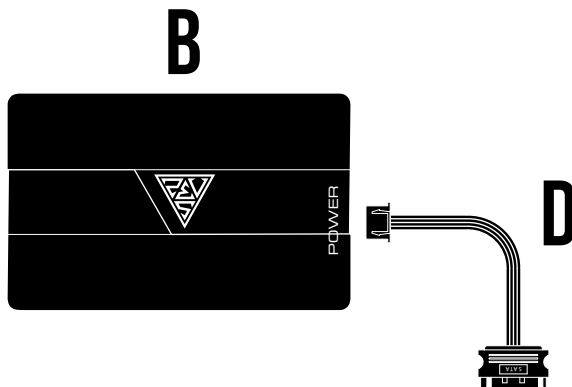



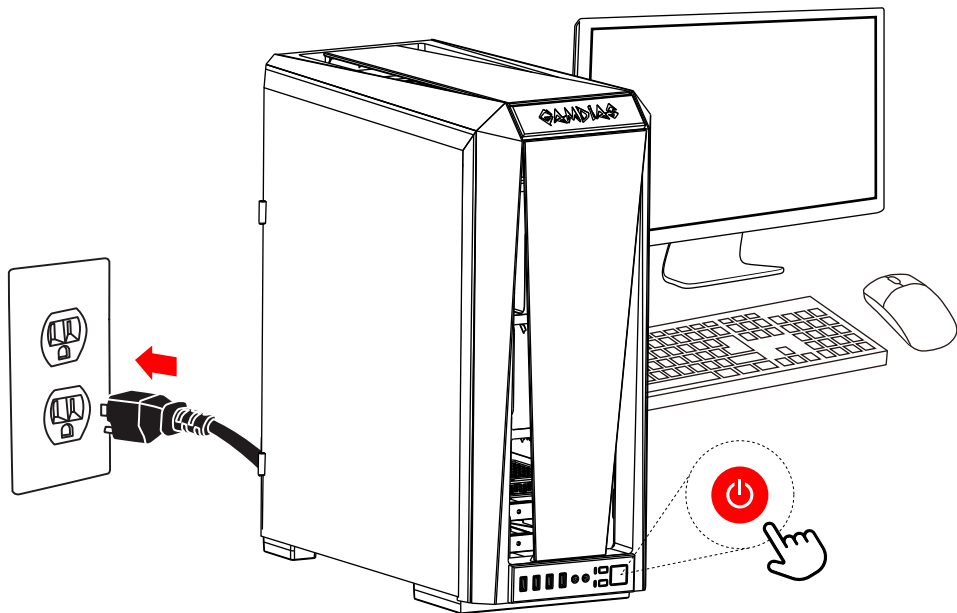















INTEL / AMD-14



INTEL / AMD-15



-   LED ON/OFF
-  Motherboard Sync
-   Mode
-   Light Speed
-   Fan Speed
-   Brightness
-     Lighting Effect
-   

INTEL / AMD-16

Product Warranty Policy	http://www.gamdias.com/warranty-en-gb
Política de la garantía del producto	http://www.gamdias.com/warranty-en-gb
Garantiebedingungen	http://www.gamdias.com/warranty-en-gb
Política de garantía do produto	http://www.gamdias.com/warranty-en-gb
Политика по гарантии продукции	http://www.gamdias.com/warranty-en-gb
Qaurantie Limitée de Produit	http://www.gamdias.com/warranty-en-gb
Condizioni di Garanzia del Prodotto	http://www.gamdias.com/warranty-en-gb
Garantipolicy	http://www.gamdias.com/warranty-en-gb
Termes de Garantie	http://www.gamdias.com/warranty-en-gb
Warunki Gwarancji	http://www.gamdias.com/warranty-en-gb
شروط ضمان منتجات	http://www.gamdias.com/warranty-en-gb



GAMDIAS

GAMING ART IN MOTION