

# QUICK INSTALLATION GUIDE



**GAMDIAS**  
**AEOLUS | M1**  
1403R  
Case & Radiator Fan

# Package Contents

**A**

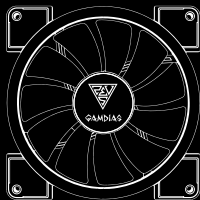

x3

**B**

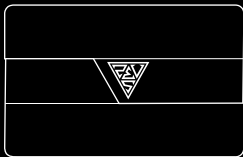

x1

**C**



x1

**D**

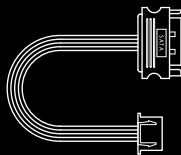

x1

**E**



x1

**F**



x1

**G**



x 12

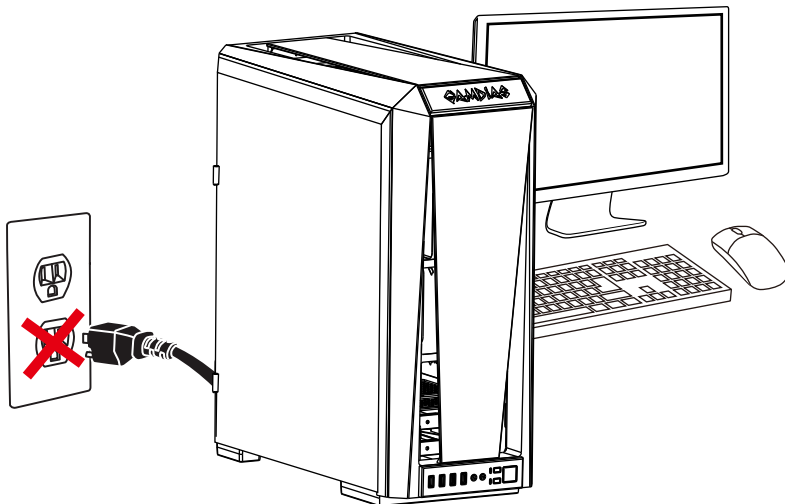

## English

- ♦ Make sure that your system is turned off and unplugged.

## Français

- ♦ Assurez-vous que le système est éteint et débranché.

## Русский

- ♦ Убедитесь, что система выключена и отключена от электросети.

## Deutsch

- ♦ Stellen Sie sicher, dass Ihr System ausgeschaltet und alle Stromkabel gezogen sind.

## Español

- ♦ Asegúrese de que el sistema está apagado y desenchufado.

## Italiano

- ♦ verificare che il sistema sia spento e scollegato.

## Português

- ♦ Certifique-se que o seu sistema está desligado e sem corrente eléctrica.

## Türk dili

- ♦ Sisteminizin kapalı olduğundan ve fişinin takılı olmadığından emin olun.

# 01

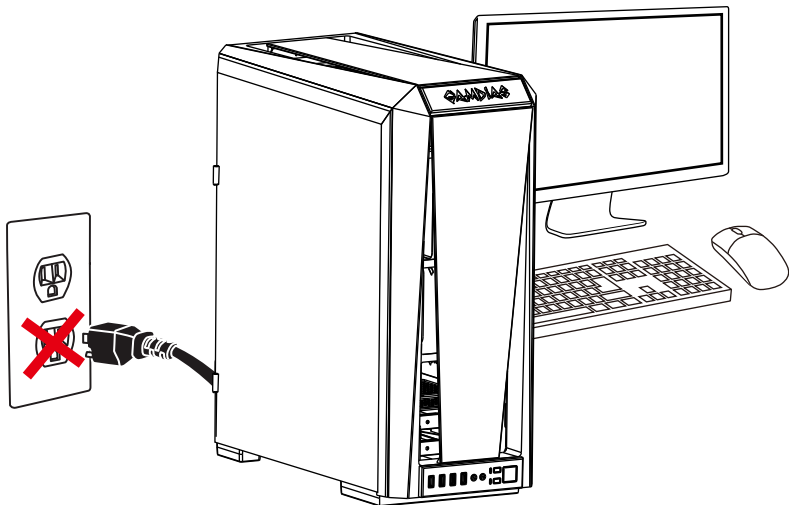

## 日本語

- ◆ システムがオフになっており、プラグを抜いていることを確認してください。

## 繁體中文

- ◆ 請確定系統已關閉且已斷電。

## ภาษาไทย

- ◆ ตรวจสอบให้แน่ใจว่าคุณได้ปิดระบบของคุณและถอดปลั๊กออกแล้วถอดสายไฟฟ้า

## 简体中文

- ◆ 请确保系统已关闭，并已拔出插头。

# 02

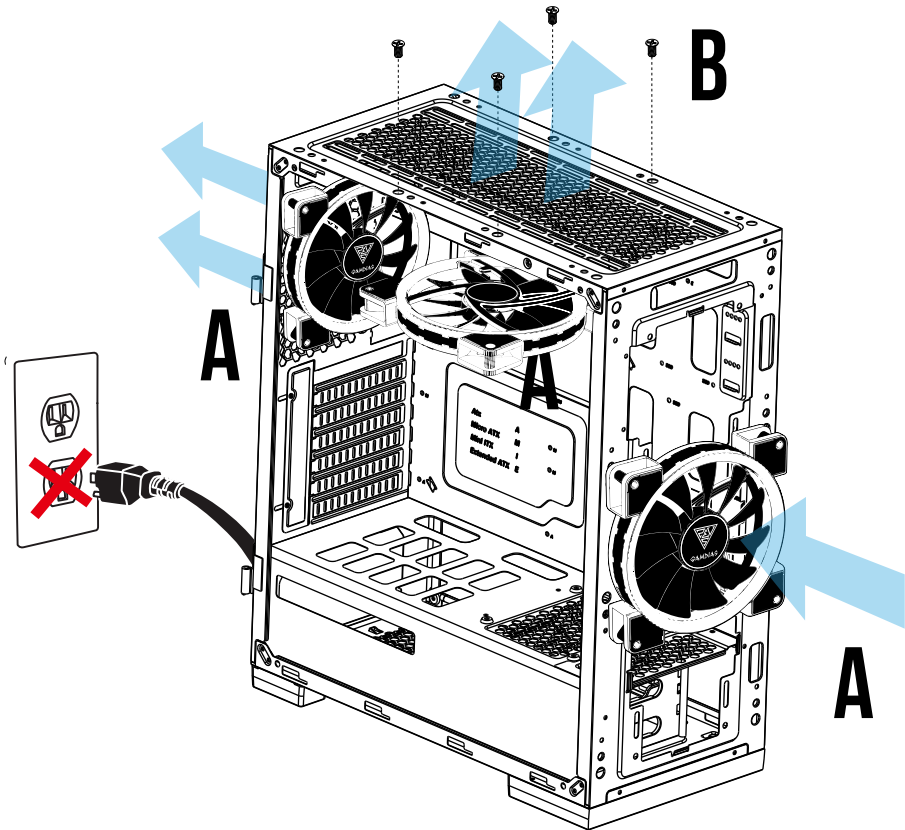

# 03

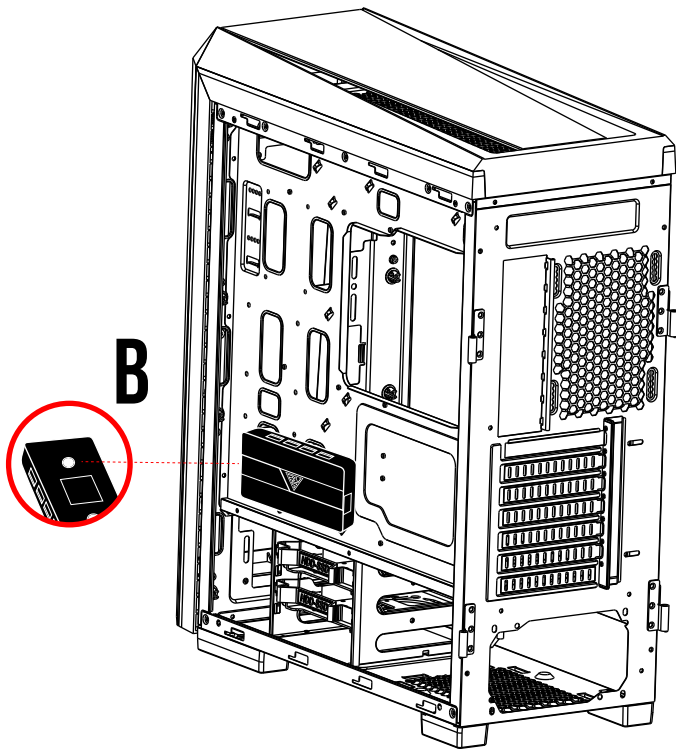

# 04

Fans must start at "FAN1" and continue in series.  
FAN1 → FAN2 → FAN3 → FAN4 → FAN5 → FAN6

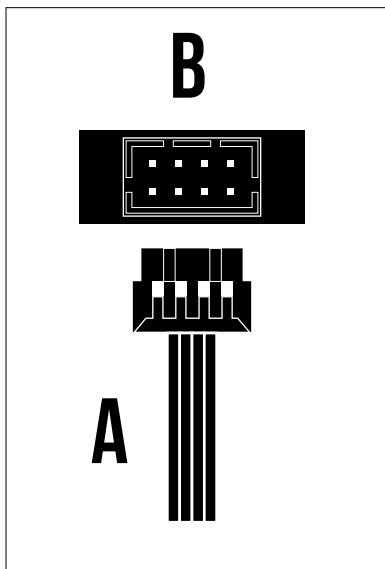
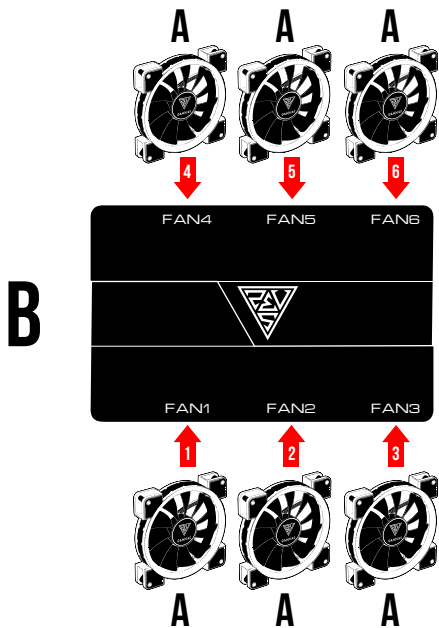

# 04

## English

- ◆ Fans must start at "FAN1" and continue in series.  
FAN1 → FAN2 → FAN3 → FAN4 → FAN5 → FAN6
- ◆ Any fan not connected in series will break communication and the RGB lighting function will not work.

## Español

- ◆ Los ventiladores deben comenzar en "FAN1" y continuar en serie.  
FAN1 → FAN2 → FAN3 → FAN4 → FAN5 → FAN6
- ◆ Cualquier ventilador no conectado en serie romperá la comunicación y no se activará la función de iluminación RGB

## Deutsch

- ◆ Lüfter müssen bei „FAN1“ beginnen und in Reihe fortgesetzt werden.  
FAN1 → FAN2 → FAN3 → FAN4 → FAN5 → FAN6
- ◆ Jeder nicht in Reihe geschaltete Lüfter unterbricht die Kommunikation und die RGB-Beleuchtung funktioniert nicht

## Polski

- ◆ Wentylatory muszą uruchamiać się przy „FAN1” i kontynuować działanie szeregowo.  
FAN1 → FAN2 → FAN3 → FAN4 → FAN5 → FAN6
- ◆ Wentylator, który nie jest podłączony szeregowo przerwie komunikację i funkcja oświetlenia RGB nie będzie działać

## Français

- ◆ Les ventilateurs doivent commencer à "FAN1" et continuer en série.  
FAN1 → FAN2 → FAN3 → FAN4 → FAN5 → FAN6
- ◆ Les ventilateurs non connectés en série rompent la communication et empêchant le fonctionnement de l'éclairage RVB



## Svensk

- ♦ Fläktar måste starta på "FAN1" och fortsätta i serie.  
FAN1 → FAN2 → FAN3 → FAN4 → FAN5 → FAN6
- ♦ Fläktar som inte ansluts i serie kommer att bryta kommunikationen och RGB-belysningsfunktionen kommer inte att fungera

## Italiano

- ♦ Le ventole devono partire da "FAN1" e continuare in serie.  
FAN1 → FAN2 → FAN3 → FAN4 → FAN5 → FAN6
- ♦ Qualsiasi ventola non collegata in serie interrompe la comunicazione e la funzione di illuminazione RGB non funziona

## Português

- ♦ As ventoinhas devem começar em "FAN1" e continuar em série.  
FAN1 → FAN2 → FAN3 → FAN4 → FAN5 → FAN6
- ♦ Qualquer ventoinha não conectada em série interromperá a comunicação e a função de iluminação RGB não funcionará

## Русский

- ♦ Вентиляторы запускаются с «FAN1» и далее по порядку.  
FAN1 → FAN2 → FAN3 → FAN4 → FAN5 → FAN6
- ♦ Если какой-либо из вентиляторов не подключен последовательно, связь прерывается, и функция подсветки RGB не работает

## العَرَبِيَّة

- ♦ يجب أن تبدأ المراوح من "FAN1" وتستمر على التوالي. FAN6 ← FAN5 ← FAN4 ← FAN3 ← FAN2 ← FAN1
- ♦ إذا لم يتم توصيل أي مروحة على التوالي، فسيتم قطع الاتصال ولن تعمل وظيفة إضاءة RGB

# 04

## Türk dili

- ◆ Fanlar "FAN1" değerinden başlamalı ve sıralı olarak devam etmelidir.  
FAN1 → FAN2 → FAN3 → FAN4 → FAN5 → FAN6
- ◆ Sıralı olarak bağlanmayan herhangi bir fan iletişimi kesecek ve RGB aydınlatma işlevi çalışmayacaktır.

## 日本語

- ◆ ファンは「FAN1」で始まり、順に続くようにしてください。  
FAN1 > FAN2 > FAN3 > FAN4 > FAN5 > FAN6
- ◆ ファンが順につながれていない場合、連携が切断され、RGB照明効果が機能しません。

## 한국어

- ◆ 팬은 "FAN1"에서 시작해 순서대로 이어져야 합니다. FAN1 > FAN2 > FAN3 > FAN4 > FAN5 > FAN6
- ◆ 순서대로 연결되지 않은 팬은 신호가 끊겨 RGB 라이트 기능이 작동하지 않습니다.

## ภาษาไทย

- ◆ พัดลมจะต้องเริ่มต้นที่ "FAN1" และต่อเนื่องไปเรื่อยๆ ตามลำดับ  
FAN1 > FAN2 > FAN3 > FAN4 > FAN5 > FAN6
- ◆ พัดลมที่ไม่เชื่อมต่อกับลำดับจะทำให้การสื่อสารขาดตอน และฟังก์ชันไฟ RGB จะไม่ทำงาน

## 繁體中文

- ◆ 風扇安裝必需從FAN1開始，並依序插入。FAN1→FAN2→FAN3→FAN4→FAN5→FAN6
- ◆ 若沒依序安裝，會導致燈光功能失效。

## 简体中文

- ◆ 风扇安装必需从FAN1开始，并依序插入。FAN1→FAN2→FAN3→FAN4→FAN5→FAN6
- ◆ 若没依序安装，会导致灯光功能失效。

# 05

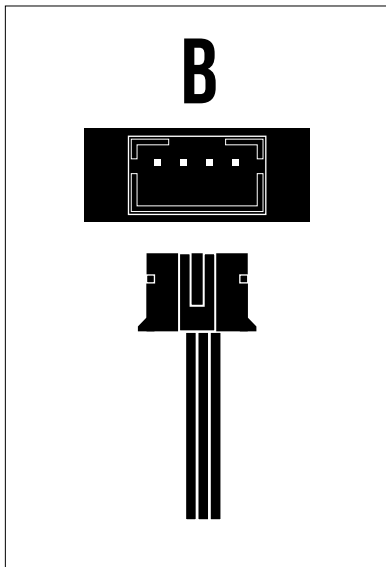
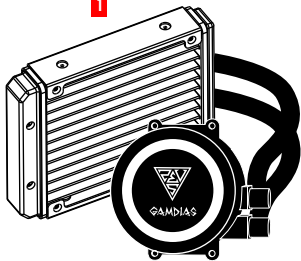
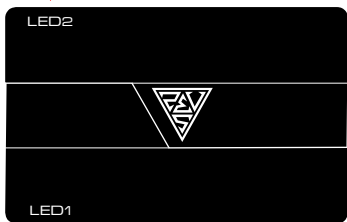
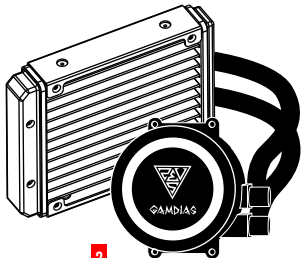



## ASUS – AURA Addressable Header

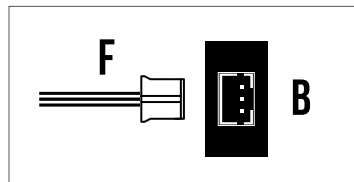
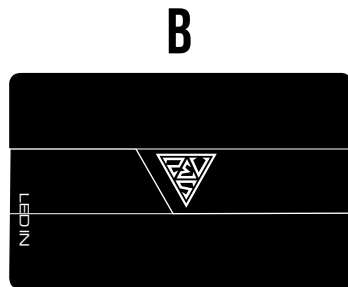
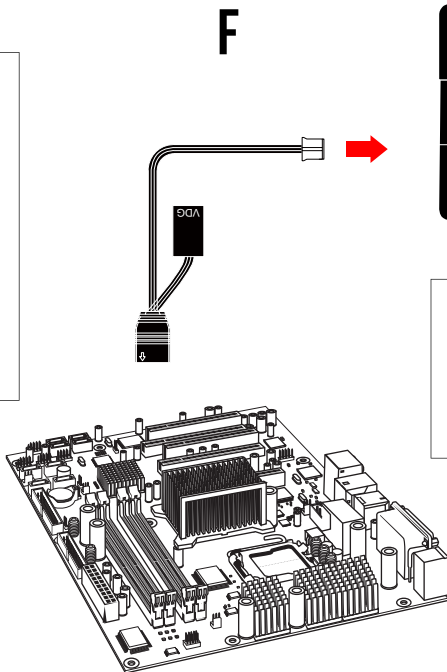
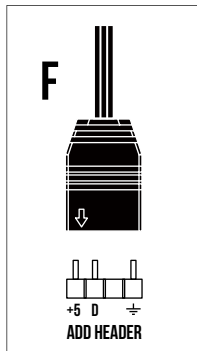

## MSI - JRAINBOW Header

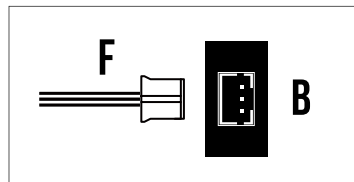
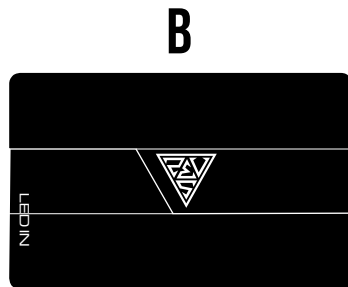
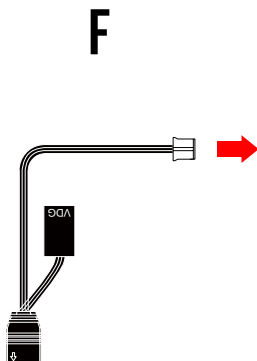
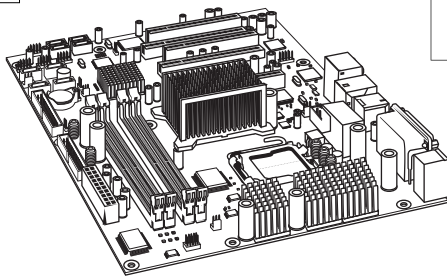
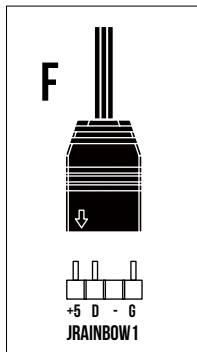



## ASRock - Addressable LED Header

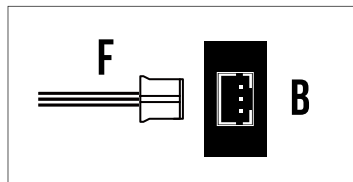
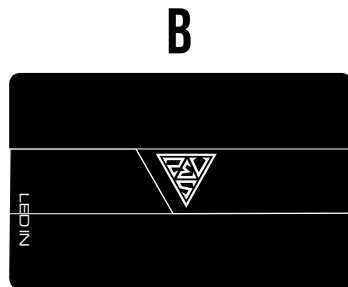
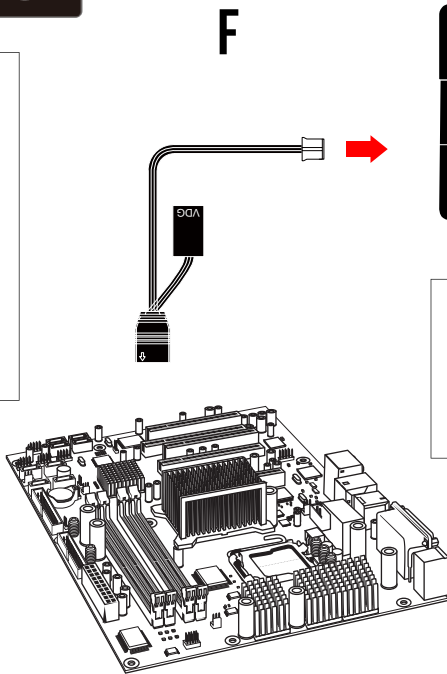
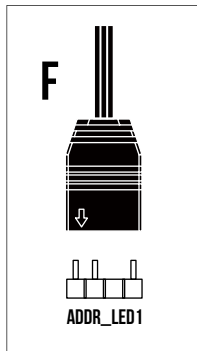



## GIGABYTE - Digital LED Header

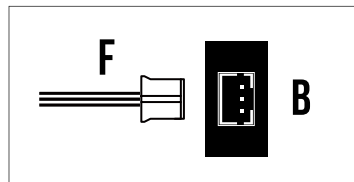
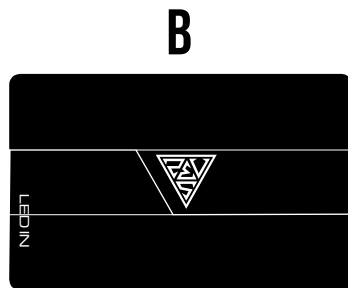
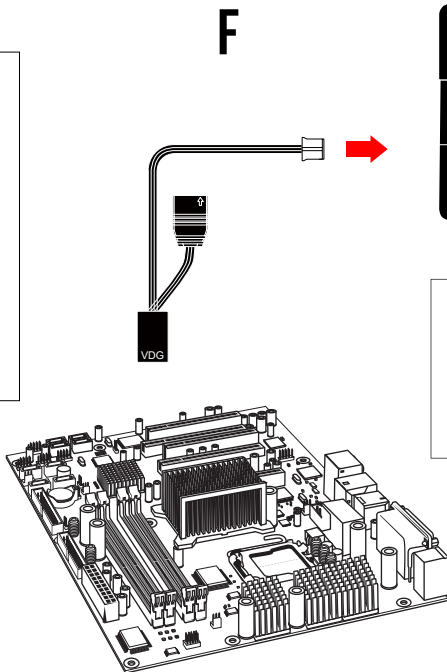
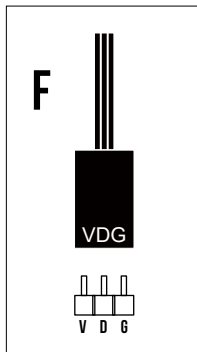

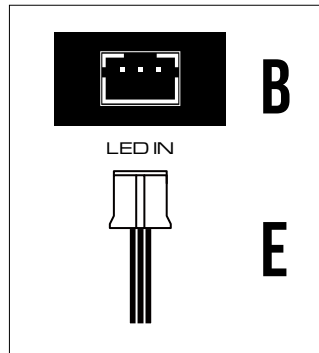
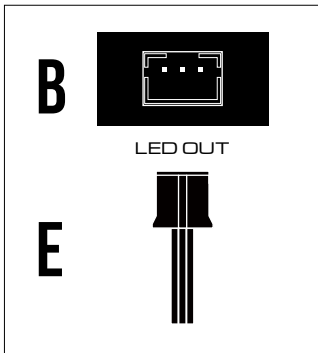
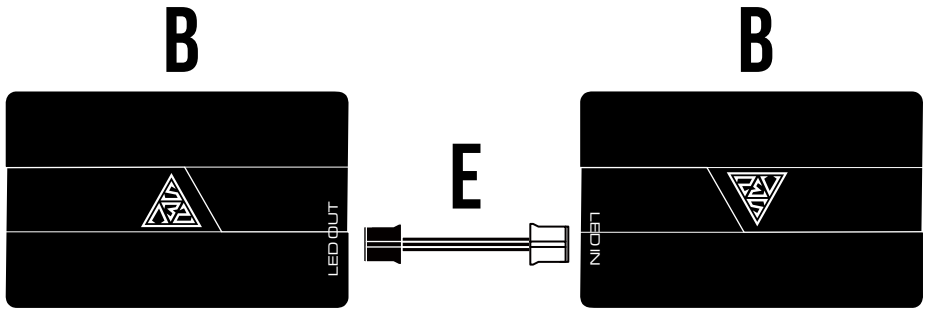



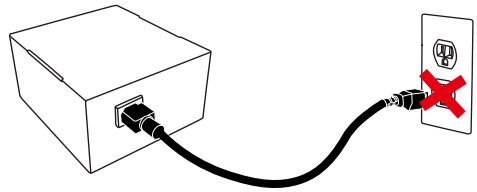
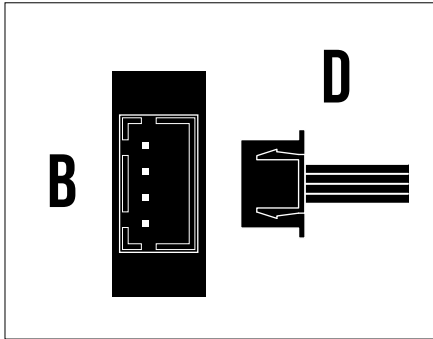
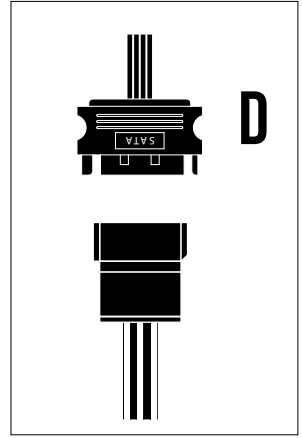
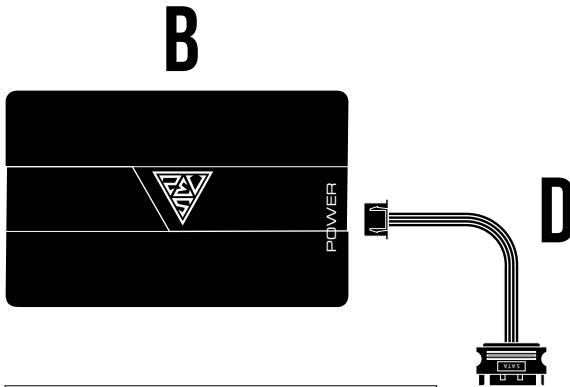

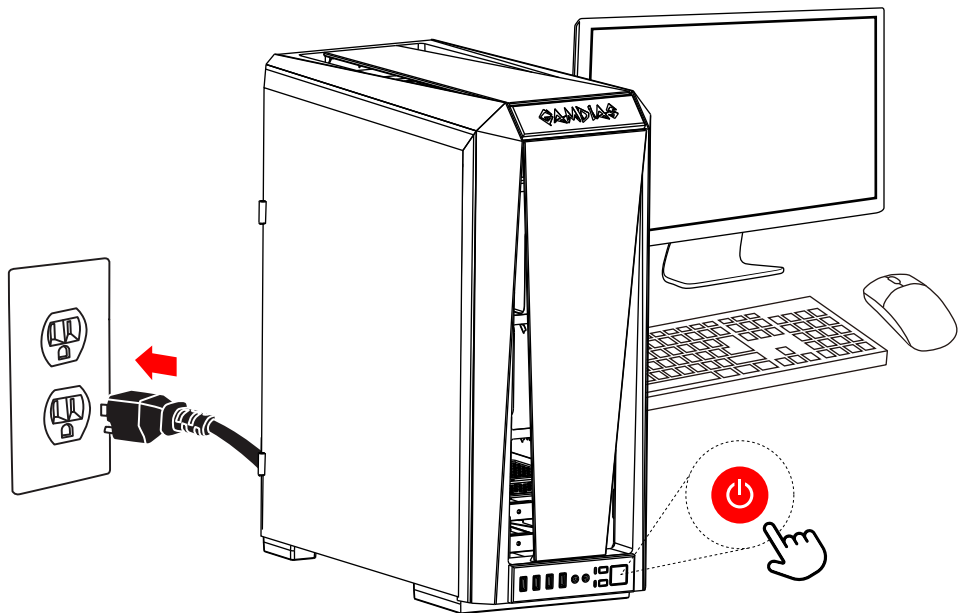





















-   LED ON/OFF
-  Motherboard Sync
-   Mode
-   Light Speed
-   Fan Speed
-   Brightness
-     Lighting Effect
-   

Product Warranty Policy	<a href="http://www.gamdias.com/warranty-en-gb">http://www.gamdias.com/warranty-en-gb</a>
Política de la garantía del producto	<a href="http://www.gamdias.com/warranty-en-gb">http://www.gamdias.com/warranty-en-gb</a>
Garantiebedingungen	<a href="http://www.gamdias.com/warranty-en-gb">http://www.gamdias.com/warranty-en-gb</a>
Política de garantía do produto	<a href="http://www.gamdias.com/warranty-en-gb">http://www.gamdias.com/warranty-en-gb</a>
Политика по гарантии продукции	<a href="http://www.gamdias.com/warranty-en-gb">http://www.gamdias.com/warranty-en-gb</a>
Quarantie Limitée de Produit	<a href="http://www.gamdias.com/warranty-en-gb">http://www.gamdias.com/warranty-en-gb</a>
Condizioni di Garanzia del Prodotto	<a href="http://www.gamdias.com/warranty-en-gb">http://www.gamdias.com/warranty-en-gb</a>
Garantipolicy	<a href="http://www.gamdias.com/warranty-en-gb">http://www.gamdias.com/warranty-en-gb</a>
Warunki Gwarancji	<a href="http://www.gamdias.com/warranty-en-gb">http://www.gamdias.com/warranty-en-gb</a>
شروط ضمان منتجات	<a href="http://www.gamdias.com/warranty-en-gb">http://www.gamdias.com/warranty-en-gb</a>
製品保証ポリシー	<a href="http://www.gamdias.com/warranty-en-gb">http://www.gamdias.com/warranty-en-gb</a>
產品保固政策	<a href="http://www.gamdias.com/warranty-en-gb">http://www.gamdias.com/warranty-en-gb</a>
产品保固政策	<a href="http://www.gamdias.com/warranty-en-gb">http://www.gamdias.com/warranty-en-gb</a>



GAMDIAS

GAMING ART IN MOTION